

DeckTok

USER MANUAL

Foldable Floor Lamp V1

1. What You Get

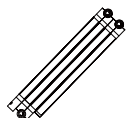

Lamp Body*1

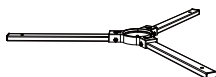

Lampe Base*1



Screw*2



Ground Cone*1



Ground Spike*3

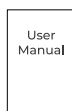

User Manual*1



Power bank*1



Type-C Through*1

If the charging distance is insufficient, use this accessory to connect the charging cable.

2. At a Glance

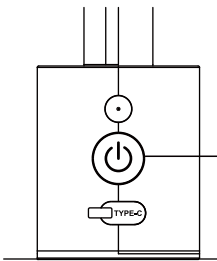
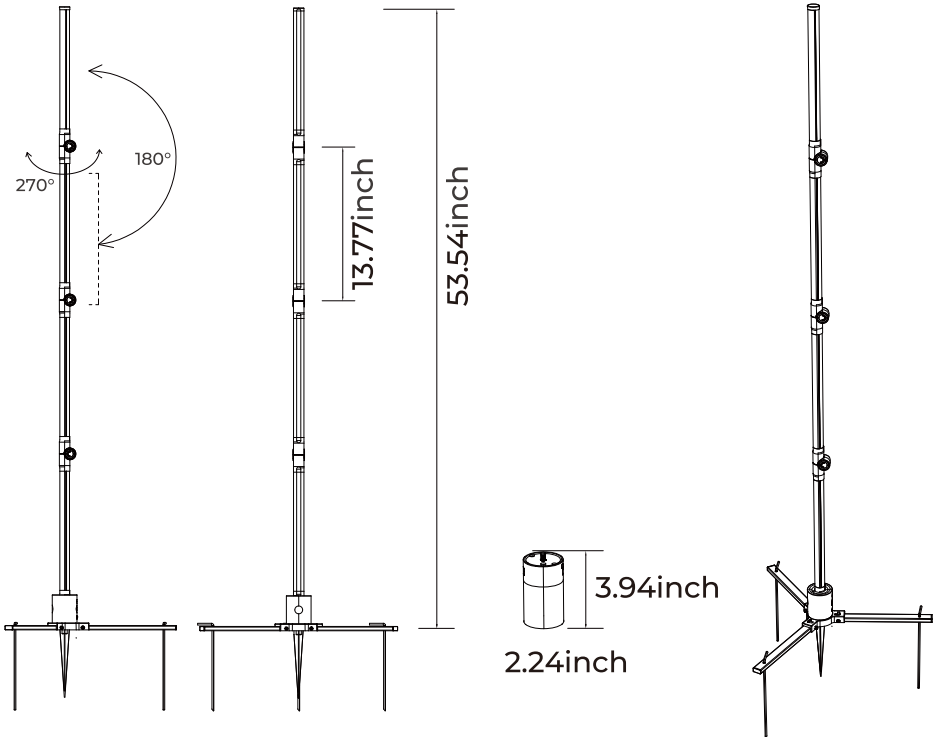

- When the light is off, click once to turn on.
- When the light is on, click twice to turn off.
- When the light is on, click once to switch the modes.
- Long press 5 seconds for red light flashing in connection network mode.

3. Setting Up The System

You'll need

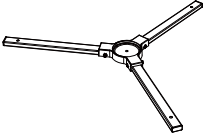

1 x



1 x



2 x



3 x

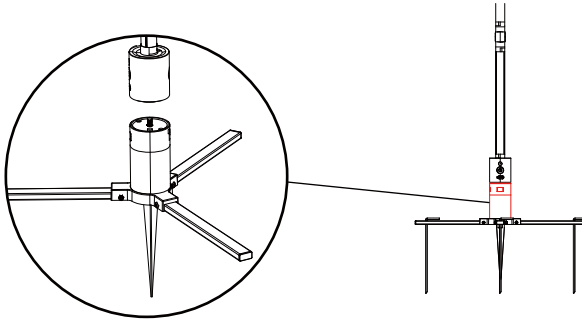

1. Connect the lamp to the dedicated power bank. Press the button on the lamp to check if it is working properly.

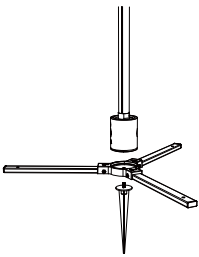

2. Connect the lamp body to the base with screw

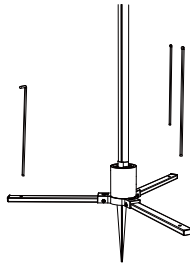

3. Insert ground Spike



4. Expand the lamp body group

4. Specifications

Lamp

Product name:	Foldable floor lamp V1
Control Methods:	App, Voice Control
Model:	DEK-L0311B
Colors: RGB	RGB
App functionality	16 Million Colors 55 Color Charts 12 Color Combinations 0~100% Brightness Adjustment Independent control of individual lamp sections 44 Dynamic Scenes+DIY Music Rhythm Timer Function Voice Control (Wi-Fi connection only) Supports group connectivity (DeckTok products only)
Rated Power:	7W
Wireless Protocols:	Bluetooth 5.0/2.4GHz Wi-Fi
Operating Temperature:	0°C to 40°C (32°F to 104°F)
Storage Temperature:	-20°C to 45°C (-4°F to 113°F)

Power bank

Product Name	Power Bank for Foldable Floor Lamp
Model Number	SC-PB-5V-10W-IP44-DFT-01
Battery Capacity	8000mAh
Rated Capacity	5920mAh
Rated Energy	29.6Wh
Input	Type-C: 5V=2A
Output	Type-A & Type-C: 5V=2A

5. FCC Compliance Statement

This device complies with Part 15 of the FCC Rules. Operation is subject to the following two conditions:

1. This device may not cause harmful interference, and this device must accept any interference received, including interference that may cause undesired operation.

The Bluetooth module in this product has been tested and certified under FCC ID:2ANDL-CBU.

The device is intended for use with a 5V battery power supply only. Unauthorized changes or modifications to this equipment could void the user's authority to operate the device.

This equipment complies with FCC radiation exposure limits set forth for an uncontrolled environment. This transmitter must not be co-located or operated in conjunction with any other antenna or transmitter.

6. Important Safety Warnings

- Please read this manual carefully and keep it for future reference. Improper use may cause fire, explosion, personal injury, or property damage.
- Do not use or store in humid, high-temperature, dusty, or flammable environments.
- Do not disassemble, pierce, crush, bend, burn, or throw the product into fire or water. Doing so may cause leakage, fire, or explosion.
- Do not store the product together with keys, coins, or other metal objects to prevent short-circuiting of the output ports.
- Do not place the product under pillows, blankets, sofa cushions, or other soft flammable materials while charging or discharging. Ensure proper ventilation.
- Do not store or use the product in high-temperature environments (such as inside a car under direct sunlight). Heat can significantly shorten battery life and increase safety risks.
- Keep out of reach of children. This is not a toy. Do not allow children to play with or handle the product.
- If the product casing is deformed, cracked, leaking, emitting odor, overheating, or showing significant performance degradation, stop using it immediately and contact customer service. Do not attempt self-repair.
- Use only the original or certified compatible charging cable. This product includes a Type-C cable for charging the product or your devices. Using substandard cables may cause poor charging efficiency, device damage, or safety hazards.
- Power bank is designed only to charge compatible electronic devices (such as smartphones, tablets, Bluetooth earphones, foldable floor lamps, etc.). Do not use with medical equipment or other devices requiring special power supply conditions.
- Ensure the input voltage meets requirements (5V-) when charging. Do not use chargers with an output voltage higher than 5V.

- This product contains a built-in lithium battery and is strictly regulated under international transport rules. Do not pack it in checked luggage. For air travel, carry it in your hand luggage with sufficient charge (generally below 100% but not completely discharged) and prevent short circuits. For specific regulations, consult your airline.
- This product complies with the EU ROHS Directive [2011/65/EU] and its amendments, restricting hazardous substances (lead, mercury, cadmium, hexavalent chromium, PBB, PBDE, phthalates, etc.)
- This product complies with the EU Battery Directive [2006/66/EEC] regarding recycling and disposal. Do not dispose of this product as unsorted household waste.

Notice

- Avoid long-term use in humid environments.
- Do not soak the product in water or other liquids.
- When installing, the screws need to be locked firmly and must not be loose.
- Do not install the product in a high temperature environment.
- The adapter needs to be connected in place, and there must be no looseness or poor contact.
- Do not disassemble or install the lamp and battery on your own. Only use the dedicated power bank or an adapter with a maximum output of 5V=2A that meets safety certification standards.
- Do not allow children to install the lamp alone.
- CAUTION: The product is not a toy. Children and the disabled should use it under adult supervision.
- Before installation, check whether the appearance, structure, and wires of lights are damaged.
- After installation, turn on the light to confirm that the light works normally.
- Charging speed may be affected by the output capacity of the power adapter, the quality of the charging cable, ambient temperature, and the current battery level of the power bank.

- The maximum total output power of this product is 10W. When charging multiple devices simultaneously, the total output current must not exceed 2A.
- When charging high-power devices, charging speed may be slower or the device may not fully charge, depending on the device's requirements.
- Before long-term storage, it is recommended to charge the battery to around 50%, and store it in a cool, dry place. Check the battery level every 3-6 months and recharge to around 50% if necessary.
- Battery capacity will naturally degrade over time as the number of charge/discharge cycles increases. This is a normal phenomenon.

7. Product Components

1. Type-A Output Port: For charging devices using cables with a Type-A connector.
2. Type-C Input/Output Port: Used to charge this product (input) or charge devices that support Type-C input (output).
3. Percentage Display Screen: Clearly shows the remaining battery percentage (e.g., 85%).

8. Instructions for Use

Charging Your Devices

1. Ensure the power bank has sufficient charge.
2. Use the included cable or a compatible charging cable. Connect one end to the output port of the power bank and the other end to your electronic device.
3. Once connected, the power bank will usually start charging your device automatically. The indicator light will remain on, indicating normal power output.
4. The percentage display screen will show the remaining battery capacity in real time.

4. When your device is disconnected, the power bank will automatically stop output. The indicator light will turn off.

Charging the Power Bank

1. Connect the Type-C cable to a compatible charger (DC output \leq 5V 2A), then plug the charger into a power outlet.
2. Once connected, the indicator light begins to flash. The percentage display indicates the current battery level and increases as charging progresses.
3. When the display shows 100%, the power bank is fully charged. The indicator light remain solid.

9. Environmental & Recycling



This product contains a recyclable lithium battery. Do not dispose of it with household waste. The

EU WEEE Directive [2012/19/EU]: This product is marked with the "crossed-out wheeled bin" symbol (see product label). It indicates that products placed on the market in EU member states must be collected and recycled separately in accordance with local regulations³. Please dispose of the product at a designated WEEE collection point.

United States: Please check the e-waste recycling regulations in your state or region and dispose of this product at a local e-waste recycling center

Proper disposal helps conserve resources and reduce environmental pollution.

12. Before Using the App

1. Download the Decktok app from the App Store (for iPhone) or from your device's app market (for Android).
2. Connect your smartphone to a 2.4GHz Wi-Fi network and enable Bluetooth.
3. Press and hold the power button on the control box for 5 seconds. When the red light starts flashing, open the app to begin network setup.
4. On the app's home screen, tap "Add Device" or the "+" icon in the upper-right corner to enter the device pairing interface.
5. Once the device is detected on the network, its icon will automatically appear in the "Add Device" screen. Tap the device icon and follow the on-screen instructions to complete pairing.

13. Register in the App

1. Download and install the DeckTok app, then sign in or create an account.



DeckTok APP



14. How to use DeckTok

1. Open the app, Tap "Sign Up" and go to the Register page.



2. Enter your phone number or email and enter the verification code, then set a password.

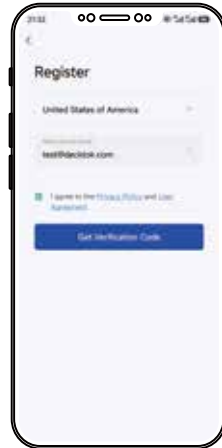

1. 3. Log in with the account name and the password you just set

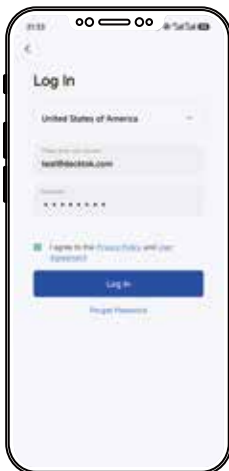

15. Add Device

1. Tap the "Add Device" button in the center of the screen, or tap the plus icon (+) in the top-right corner and then select "Add Device" from the menu.

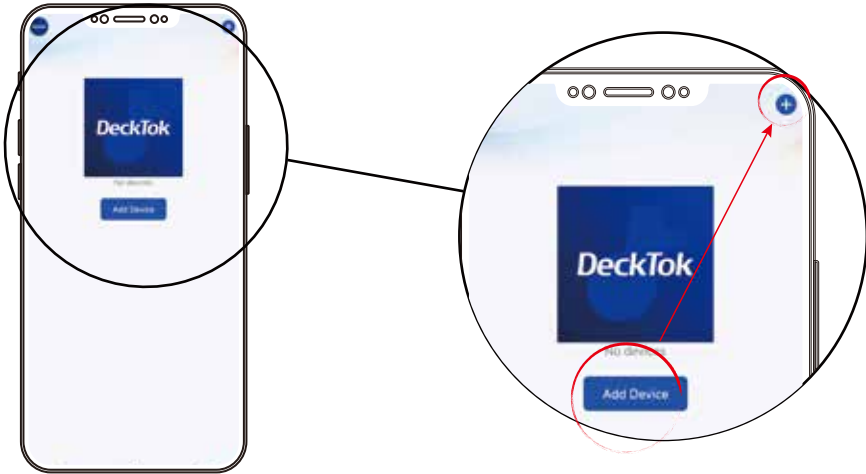

2. Tap the discovered device to enter the network setup page.

3. Select the Wi-Fi network you want to connect to, enter the password, and allow the device to join the control system.



4. You can now see your device icon on the homescreen. Tap the switch button to turn the light on or off, and tap the product icon to enter the detailed control interface.

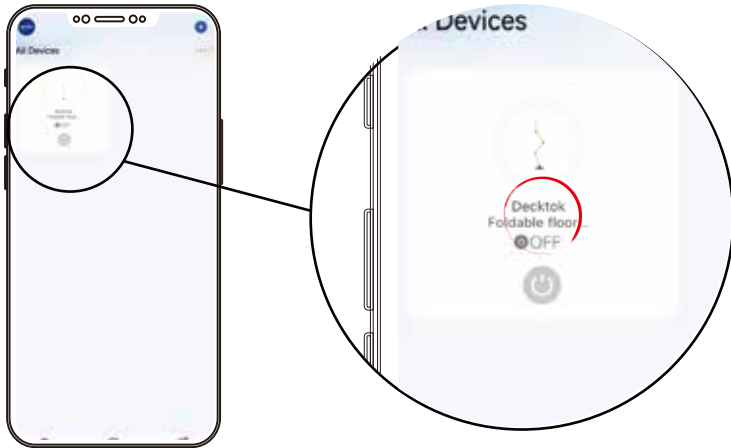

15. App Functions



16 Million Colors

- 1 Color : Broad spectrum of colors to create the perfect ambience.
- 2 Brightness: Increase or decrease light brightness.
- 3 ON/OFF: Press to power floor lamp ON/OFF.

55 Color Charts



12 Color Combinations



Independent ON/OFF Control

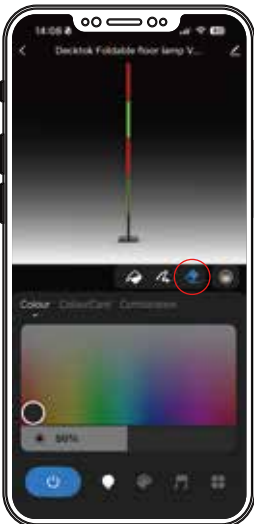

Supports independent control of individual light sections' on/off state

Independent Control of Color and Brightness

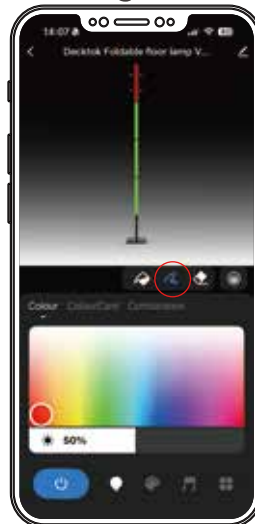

Supports independent control of individual light section's color and brightness

44 Dynamic Scenes

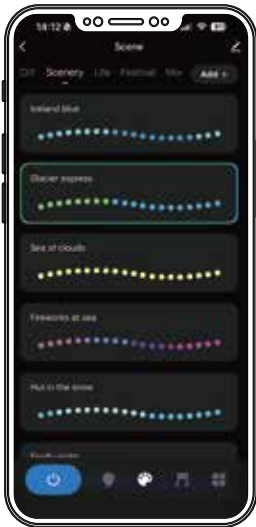

Supports DIY Dynamic Scenes

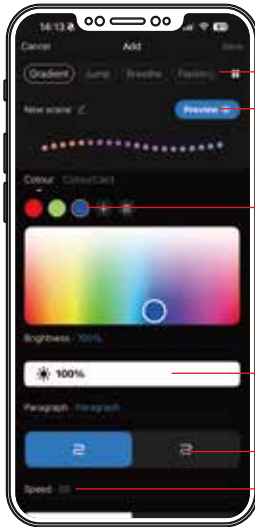

Dynamic Effects (16 types)

Custom Name and Effect Preview

Each LED Color (Color or Color card)

Brightness (0~100%)

Full or Partial

Speed (1-100)

Music Rhythm

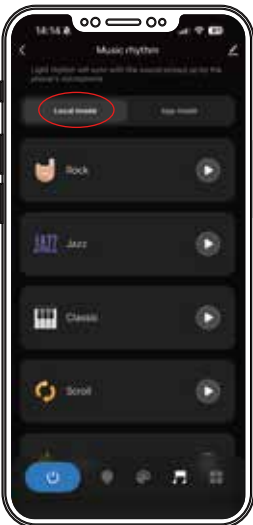

6 Local Modes

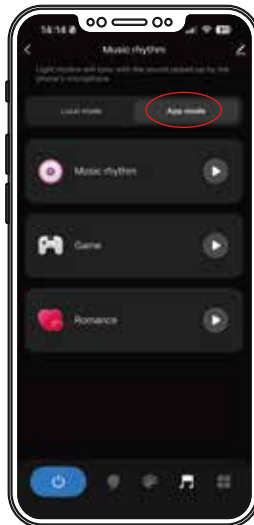

3 APP Modes

Can recognize music from the phone, and can also recognize ambient sounds (speaking, music, game sounds, TV sounds)

Timer Function

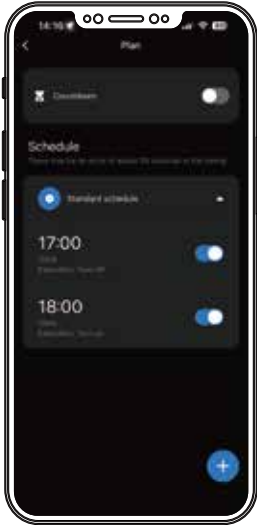

You can choose to turn the light on or off at a specific time

Voice control

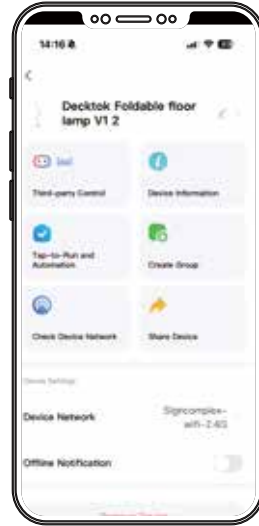

Supports connection to Alexa and Google Assistant. This function is only available with a Wi-Fi connection; It's not available with a Bluetooth connection.

17. Group Control Setup

- 1. Tap the pen icon in the upper-right corner.
- 2. Tap "Create Group."

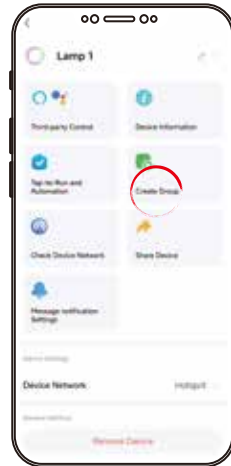

- 3. Tap the green "+" icon to add devices you want to include in the group (it is not recommended to add devices of different types, as this may lead to inconsistent control behavior), then tap the "Save" button in the upper-right corner.

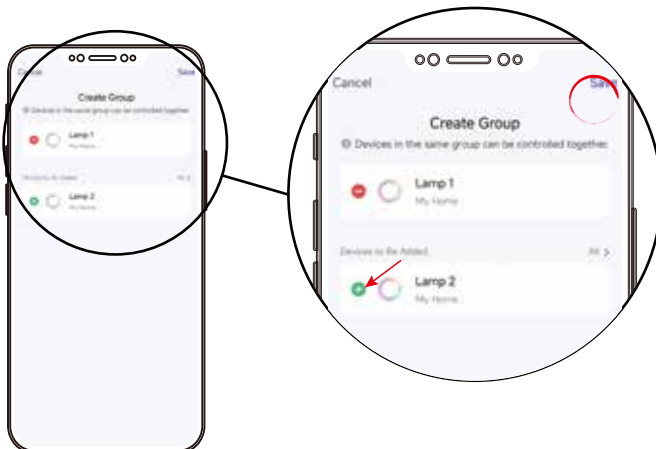

4. Name the group, select the room location for the group, and tap the "Finish" button.



5. The main control screen will display the group you have set up, Tap the switch button to turn the group on or off, and tap the group icon to enter the detailed control interface.

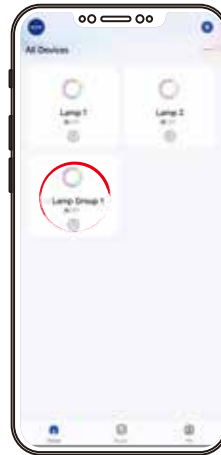

18. Voice Control Setup

1. On the Me page, tap the Alexa icon.

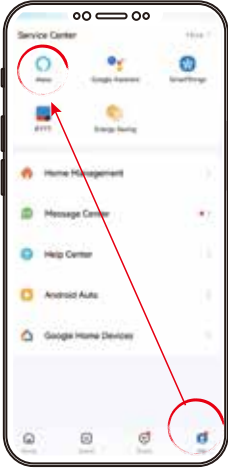

2. Tap "Link to Amazon Alexa" button.



3. The page will redirect to the Amazon website; please log in to your Amazon account following the on-screen instructions.

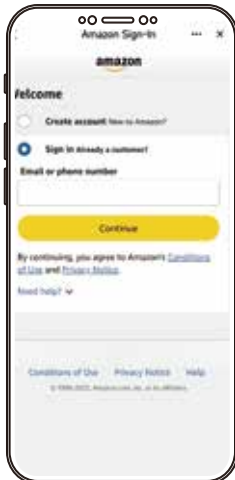

4. Tap "Allow"



5. Alexa connection is complete. You can now control your devices using Alexa voice commands.

For example:

“Alexa, please turn on the floor lamp.”

“Alexa, please adjust the floor lamp's color to pink.”

“Alexa, please adjust the floor lamp's brightness to 50%.”

“Alexa, please turn off the floor lamp.”

.....



If you wish to connect to other voice control platforms such as Google Assistant, you can complete the integration by following similar setup steps.

19. Warranty Information

Decktok provides a one-year limited warranty for this product starting from the date of purchase.

Warranty Coverage:

Defects in materials or workmanship under normal use.

Warranty Exclusions:

1. Damage caused by misuse, improper handling, accidental drops, water ingress, fire, or natural disasters.
2. Unauthorized repairs, modifications, or disassembly.
3. Normal wear and tear, as well as natural battery capacity degradation (within reasonable limits).
4. Damage caused by using non-original or incompatible accessories.

For warranty service, please provide the product, proof of purchase (invoice or receipt), and this manual to your retailer or contact Decktok Customer Service directly.

Warranty policies may vary by region. Please visit <https://cdecktok.com/> for detailed information.

20. Compliance Marks



21. Troubleshooting

1. Unable to connect to the App

- Ensure the lamp is powered on.
- Check that Bluetooth is enabled on your phone.
- Long press the button on the lamp until the lamp light flashes to activate pairing mode.

2. The light does not glow

- Check if the power source is functioning properly.
- Make sure the lamp is turned on using the button correctly.
- Disconnect the power and reconnect all components, then reconnect the power source.
- If the issue persists, please contact DeckTok official customer service.

Customer Service

Company Name: Decktok Co., Ltd.

 www.decktok.com

 Contact number: +1 628 304 2015

 info@decktok.com

 WhatsApp: +8526741 3519

